

FURAÇÃO DO PERFIL

PROFILE DRILLING | PERÇAGE DE PROFIL

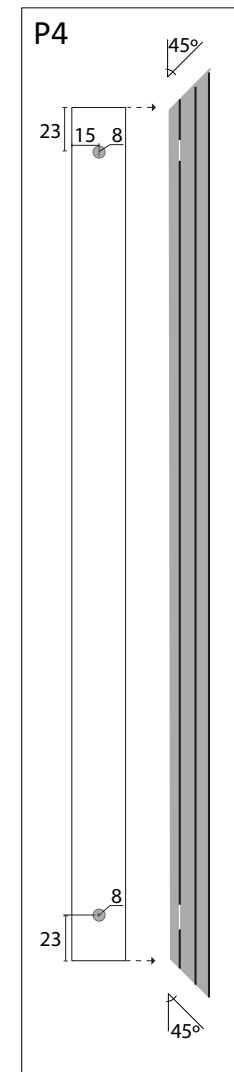
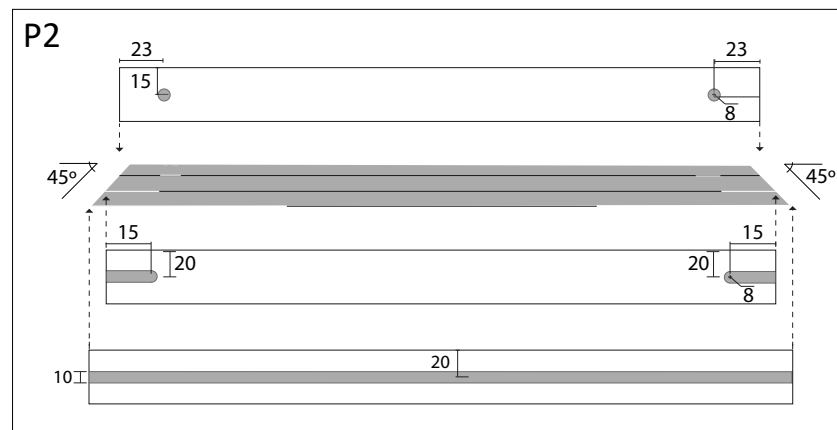
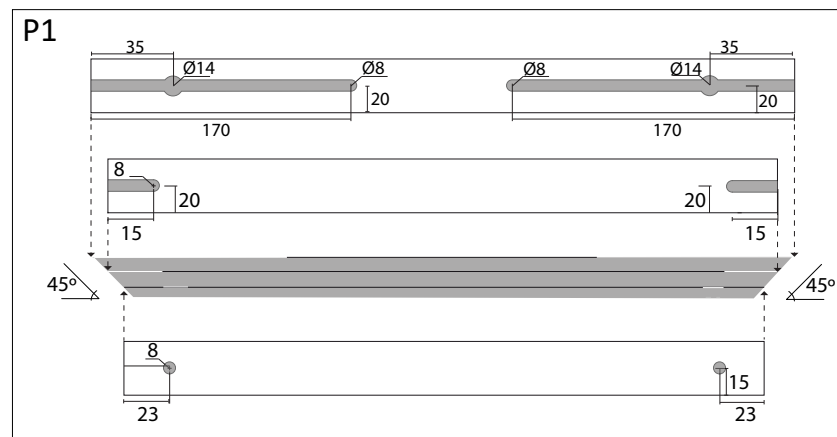
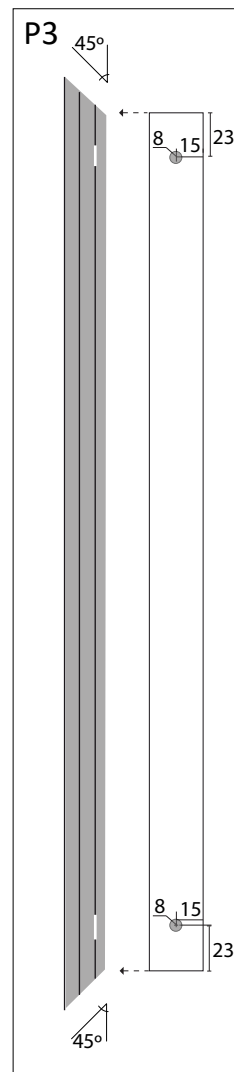

 **DIMENSÃO MÁXIMA**
MAXIMUM DIMENSION | DIMENSION MAXIMALE
1200 x 2600 MM

*A quantidade varia conforme a dimensão do sistema | The quantity varies accordingly to the system dimension | Quantité variable selon la largeur du kit

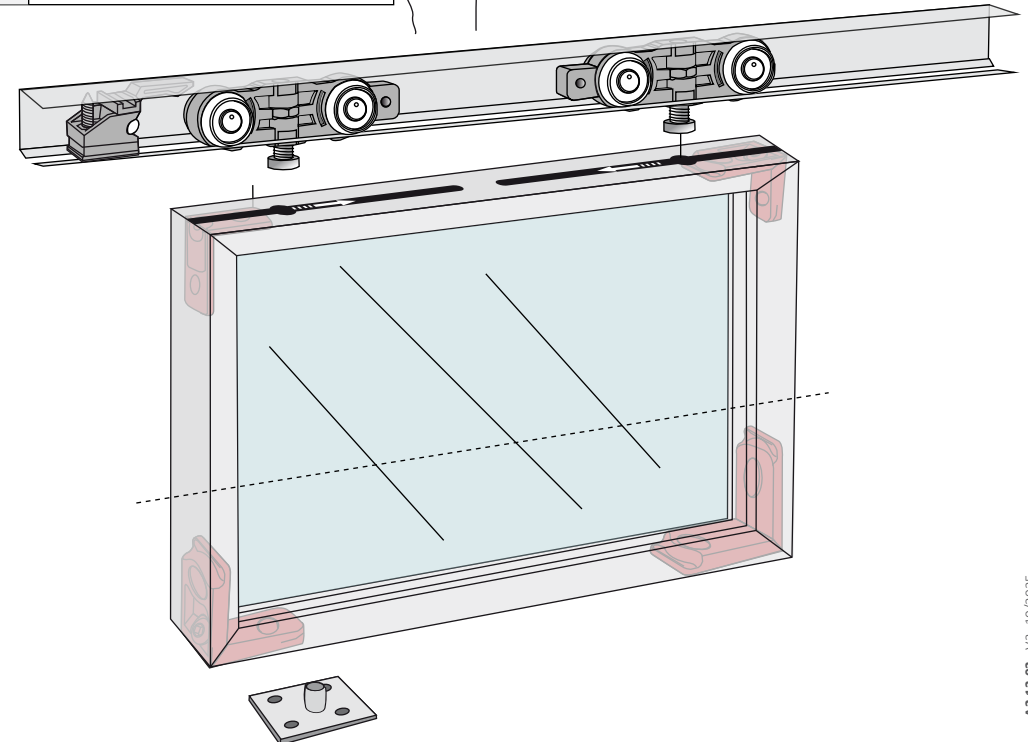
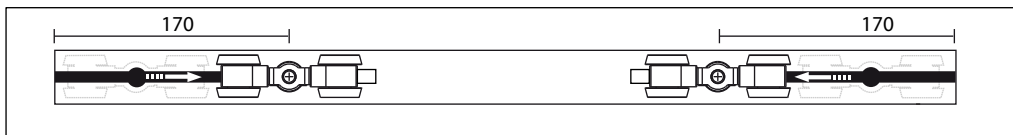
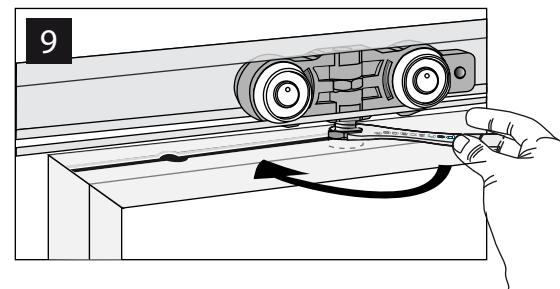
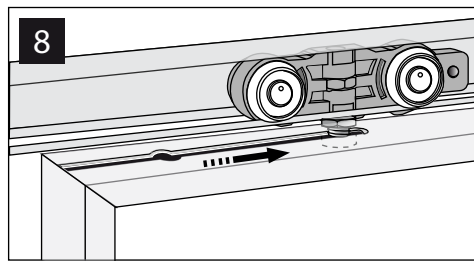
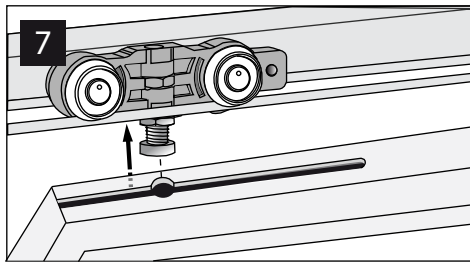
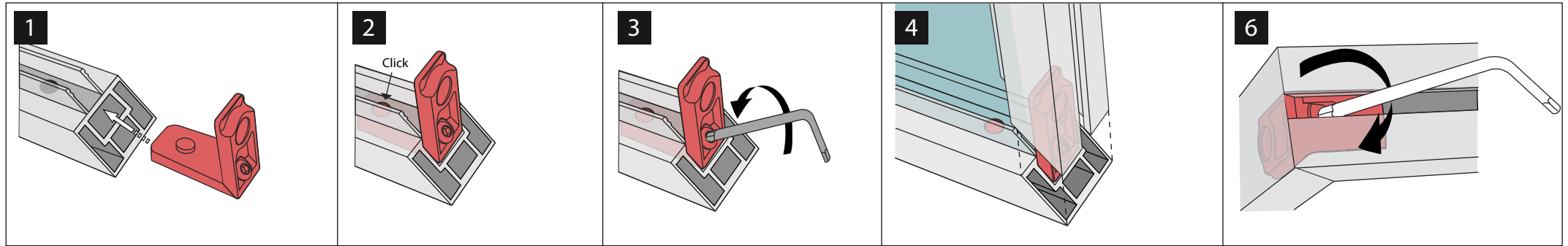

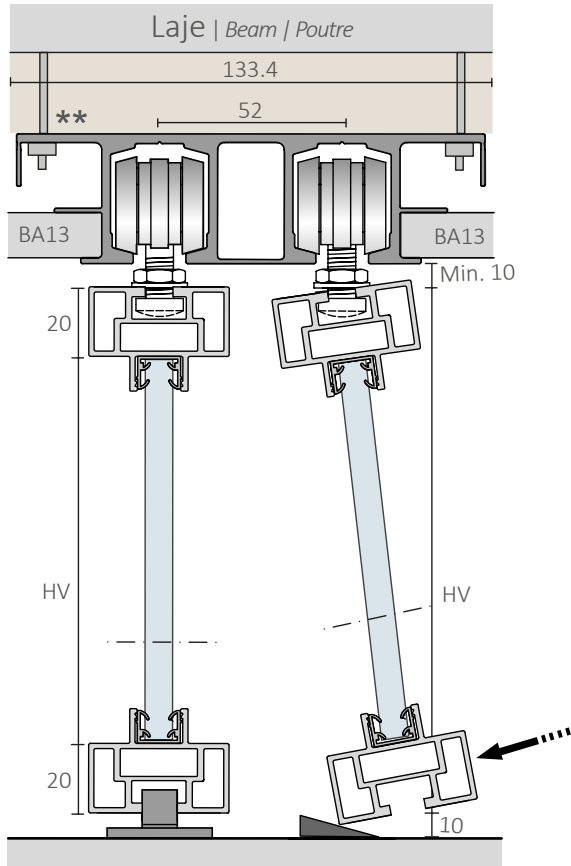

1 Porta + 1 Porta fixa

Door | Porte Fixed Door | Porte fixa

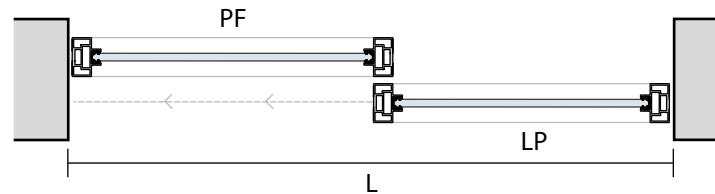

PORTA DOOR PORTE	
HP = H-20	LP = $\frac{L}{2} + 10$
HV = HP-44	LV = LP-44

1 Porta + 2 Portas fixas

Door | Porte Fixed Doors | Portes fixas

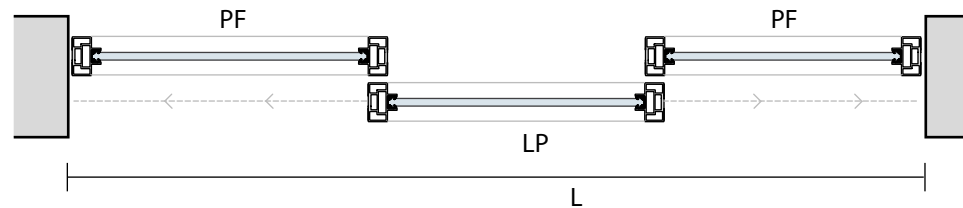

PORTA DOOR PORTE	
HP = H-20	LP = $\frac{L}{3} + 13.33$
HV = HP-44	LV = LP-44

2 Portas + 2 Portas fixas

Doors | Portes Fixed Doors | Portes fixas

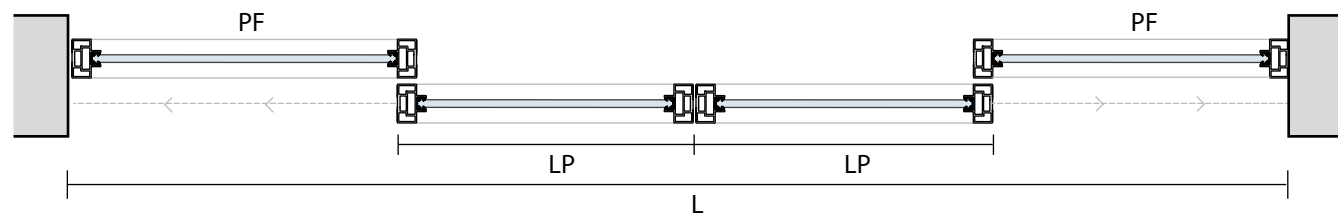

PORTA DOOR PORTE	
HP = H-20	LP = $\frac{L}{4} + 10$
HV = HP-44	LV = LP-44

- PF - Porta Fixa
Fixed door | Porte fixe
- HP - Altura da porta
Door height | Hauteur de la porte
- LP - Largura da porta
Door width | Largeur de la porte
- HV - Altura do vidro
Glass height | Hauteur de verre
- LV - Largura do vidro
Glass width | Largeur Verre