

KIT ACESSÓRIOS

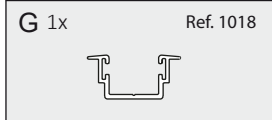

NECESSÁRIO

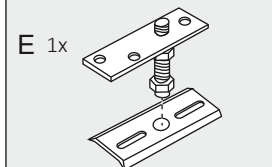
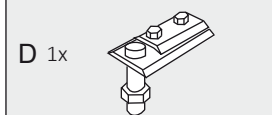
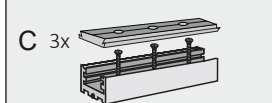
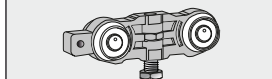
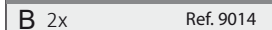
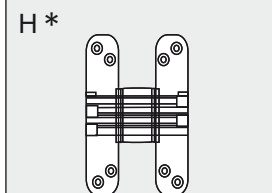

Peso Máximo:
40 Kg/porta

Dimensão máxima porta:
Largura: +- 800 mm
Altura: 2600 mm

*Dobradiças não incluídas

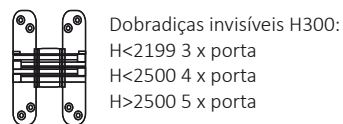

Fixação ao teto

PORTA

■ Cálculo de Largura da porta

$$LP = \frac{L-19}{4}$$

Sistema Esquerdo

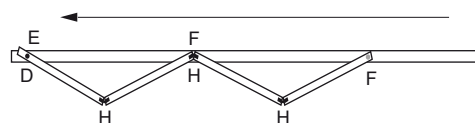
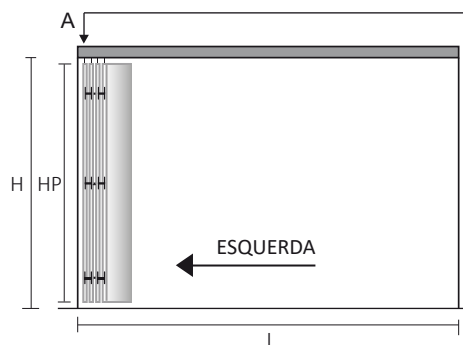

Sistema Direito

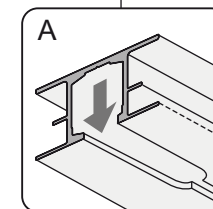
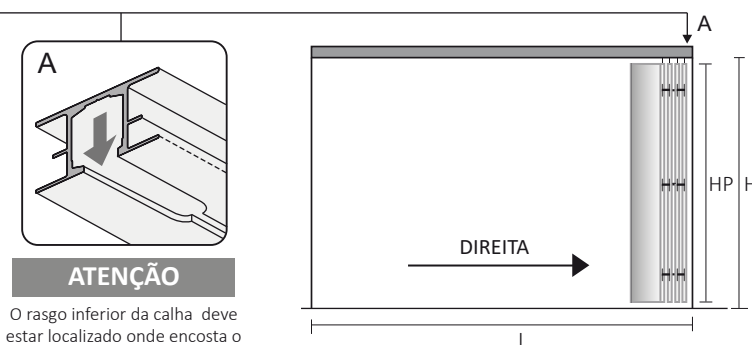

ATENÇÃO

O rasgo inferior da calha deve estar localizado onde encosta o sistema depois de aberto.

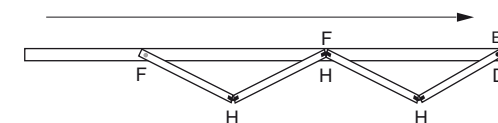

1 Calha nº5
Ref:1038

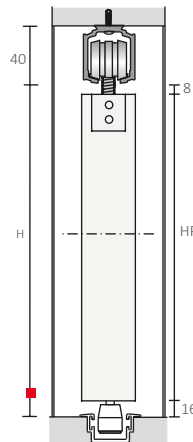

Calha nº6
Ref:1040

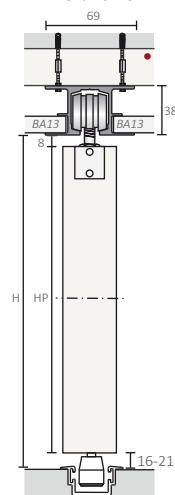

Calha nº6C
Ref:1037

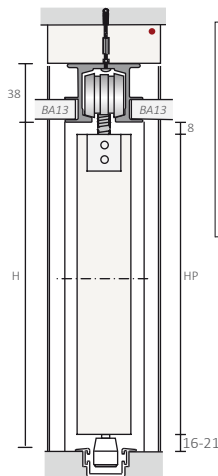

Kit de acessórios de fixação

Fixing accessories Kit | Kit accessoires de fixation
Não incluído | Not included | Non inclus

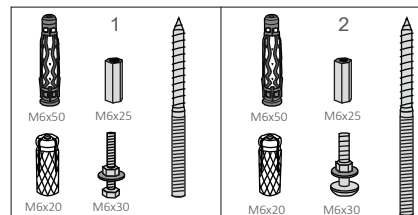

	REFERÊNCIA REFERENCE RÉFÉRENCE	CALHA Nº TRACK NR. RAIL Nº	DIMENSÃO DIMENSION DIMENSION
1	11.0315.001	6 6D	2000
	11.0315.002	6 6D	3000
	11.0315.003	6 6D	4000
	11.0315.004	6 6D	6000
2	11.0315.005	6C	2000
	11.0315.006	6C	3000
	11.0315.007	6C	4000
	11.0315.008	6C	6000

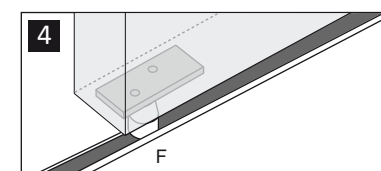
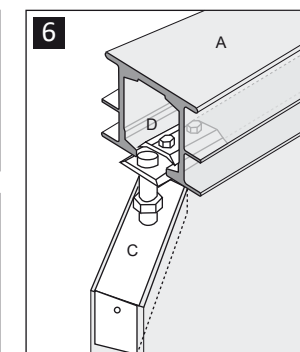
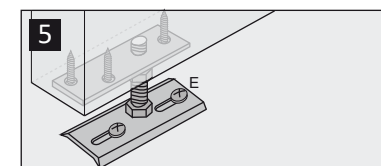
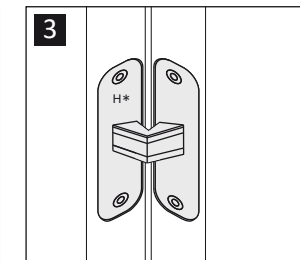
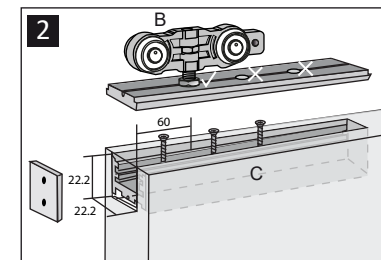

* Quantidade depende da dimensão e peso da porta.

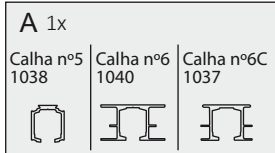

KIT ACESSÓRIOS

B 2x Ref. 9014

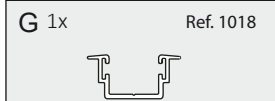
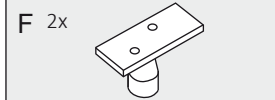
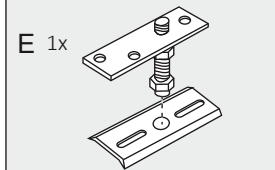
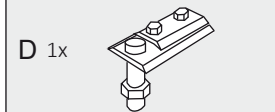
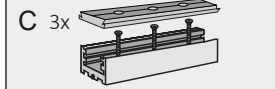
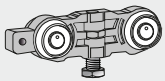

NECESSÁRIO

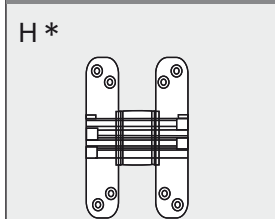

ABERTURA À ESQUERDO

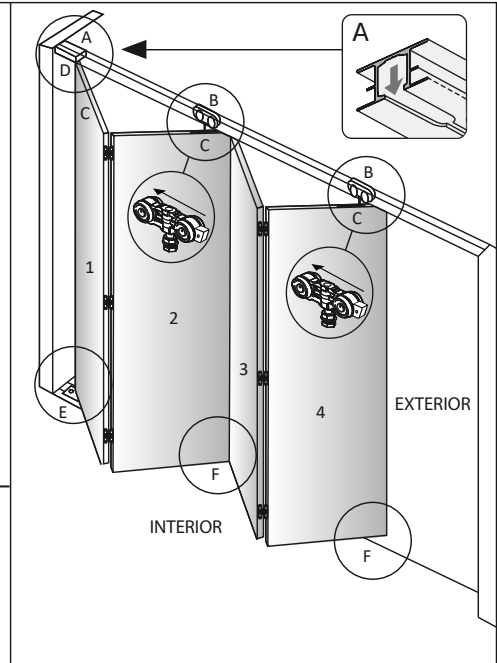
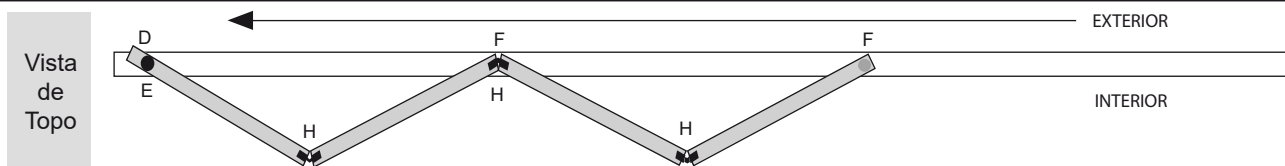
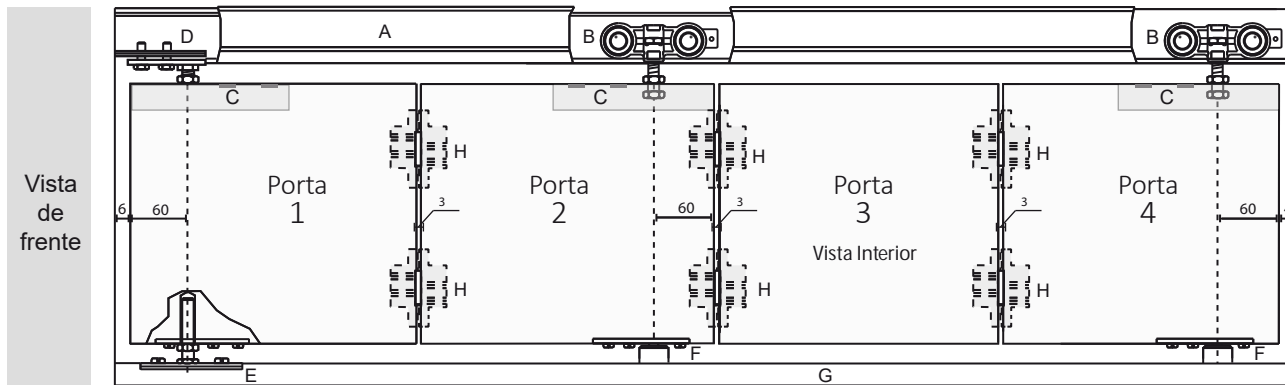

ABERTURA À DIREITO

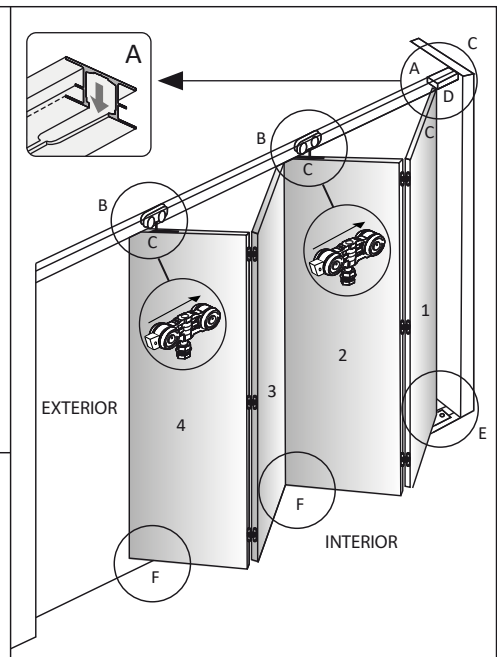
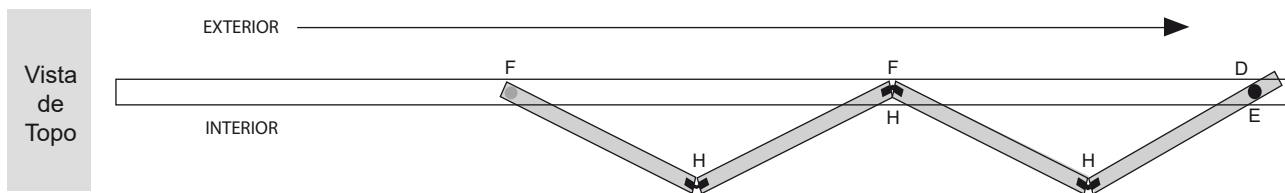
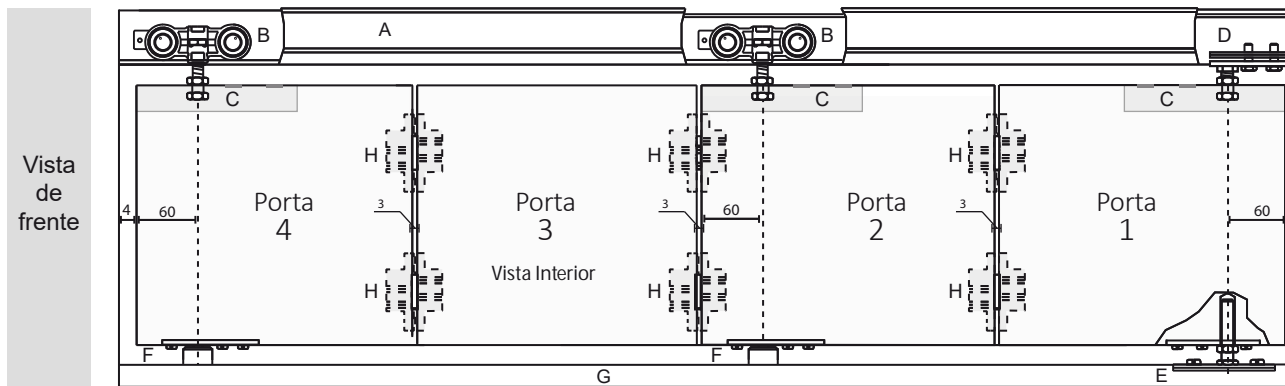

* Quantidade depende da dimensão e peso da porta.